

# CMC<sup>®</sup>

AERIAL PLATFORMS

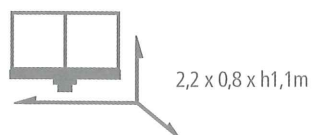

## PLJ250

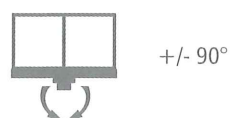
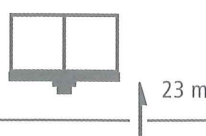
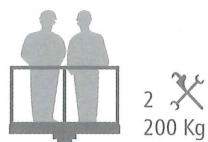
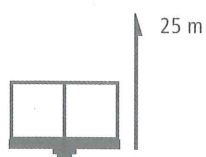

**SINCERT**

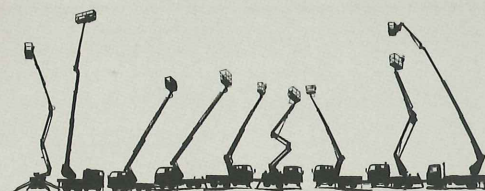

# CMC PLJ250

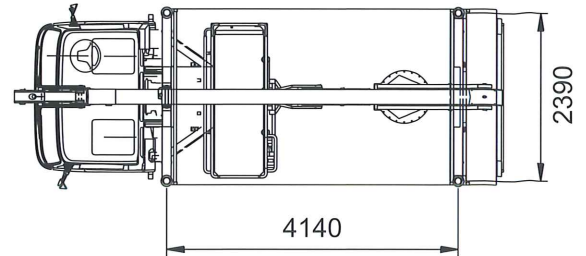
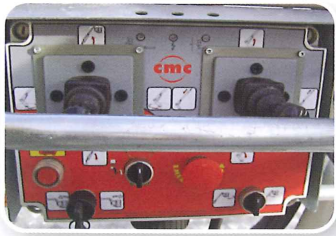
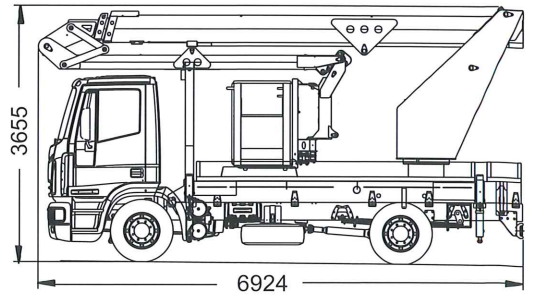
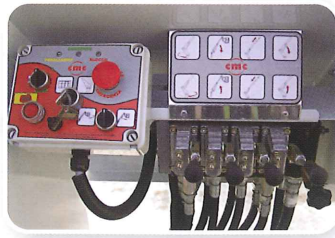
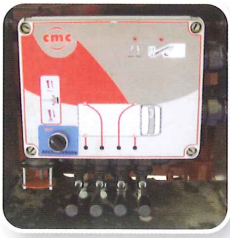

 MAX CAPACITY 200 KG

 MAX CAPACITY 80 KG

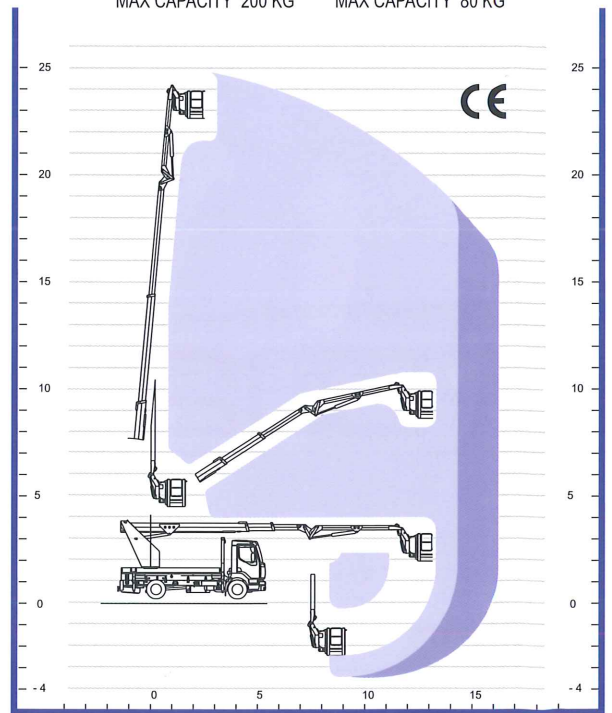

\* Changeable data according to the truck

INK STUDIO ITALIA

**C.M.C. Srl** Sede di Bari: S.P. 231 Km 1+900 - 70026 Modugno (Ba) ITALY - Tel. +39 080 5326606 - fax +39 0805368541  
 Sede di Milano: Via Piemonte, 29 - 20098 San Giuliano Milanese (MI) ITALY - Tel. +39 0298282988 - fax +39 0298287773

[info@cmclift.com](mailto:info@cmclift.com)  
[www.cmclift.com](http://www.cmclift.com)

- Dati e dimensioni possono subire modifiche senza alcun preavviso.
- Data and sizes may undergo some variations without prior notice.
- Données et dimensions pourraient subir des variations sans aucun préavis.
- Angaben und Größen können ohne Anweisungen Veränderungen hervorbringen.
- Datos y dimensiones pueden ser modificados sin preaviso.